

Data Sheet



Article number: 03704010

Description: Fluro rod end BRM 10
with ball bearing

Measures

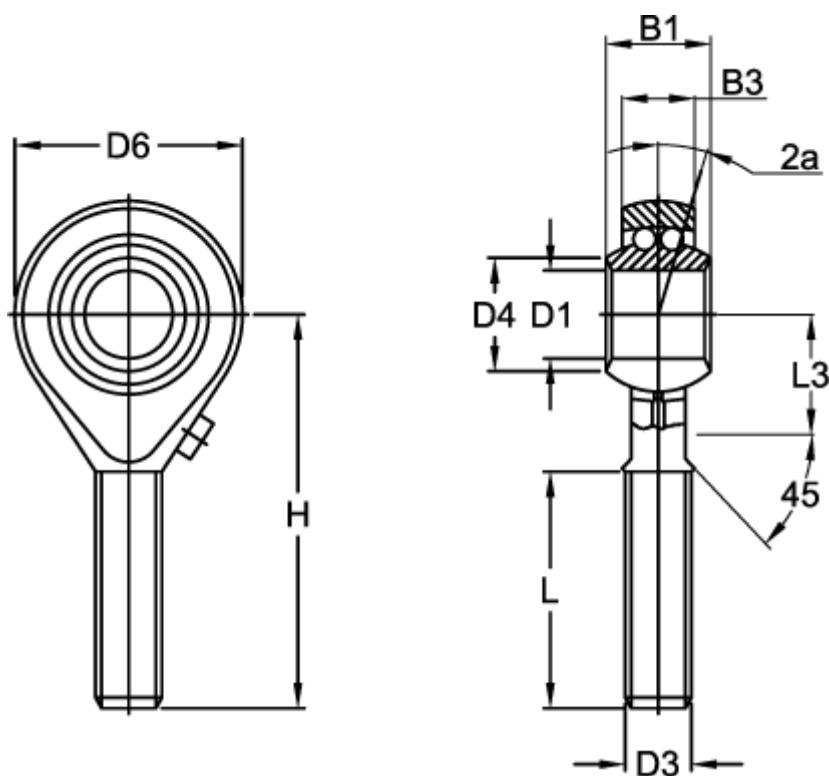

Angel 2a	= 8.0	H	= 48
B1	= 14	L	= 29
B3	= 10.50	L3	= 15
D1	= 10	Max rpm	= 1225
D3	= M10x1,5	Static load (N)	= 1450
D4	= 12.0	Weight (kg)	= 0.060
D6	= 28		
Dynamic load C (N)	= 4450.0		